



COMPANY PRESENTATION

8th Annual Berenberg Pan-European Discovery Conference USA

16th & 17th November 2022



Member of
**Euronext
Tech Leaders**

EURONEXT
Tech Leaders

EURONEXT



Certain statements in this slide show, including those addressing the Company's beliefs, plans, objectives, estimates or expectations of possible future results or events, are forward-looking statements. Forward-looking statements involve known or unknown risks, including general economic and business conditions, and conditions in the industry we operate and may be affected should our assumptions turn out to be inaccurate. Consequently, no forward-looking statement can be guaranteed and actual future results, performance, or achievements may vary materially from those expressed or implied by such forward-looking statements. The Company undertakes no obligation about the contents nor to update the forward-looking statements to reflect events or circumstances that may arise after the date hereof.



- 1. Overview
- 2. Markets and Growth drivers
- 3. Innovation: products & applications
- 4. Financial Highlights
- 5. Current Outlook
- 6. Multiples & Comparables

OVERVIEW





A PRIMARY PLAYER PROVIDING MEDICAL, INDUSTRIAL AND CONSERVATION LASER SOLUTIONS WORLDWIDE



World Class Hi-Tech company

Hi-Tech industrial group providing laser solutions with proprietary technologies and know how developed over 40 years



Listed on Milan's Stock Exchange Star segment since year 2000 and member of Euronext Tech Leaders



Within Worldwide leaders in its space

Active worldwide on several laser application segments and markets...



...progressively widening its worldwide presence achieving continuous growth over the years



>40

YEARS OF EXPERIENCE



>20

SUBSIDIARIES

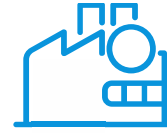

8

COUNTRIES WITH
DIRECT PRESENCE



13

PLANTS

WE CREATE LIGHT, ENERGY, WAVES



MEDICAL

Our energy based systems improve people's well-being and life quality.

In the **SURGICAL SECTOR**, our minimally invasive technology systems minimize pain, side effects and risks of surgical procedures and hospitalization days.

In the **AESTHETIC SECTOR**, our systems satisfy the growing desire of individuals to improve their appearance also reducing pathological or painful imperfections.



INDUSTRIAL

Our **LASER CUTTING** and **MARKING SYSTEMS** Improve the productivity of our customers manufacturing plants also limiting the environmental impact of manufacturing processes minimizing waste, fumes generated by the process, use of chemical additives, and allowing to eliminate the need for inks, solvents or glues within the process.



CONSERVATION

Our **LASER SYSTEMS PRESERVE** artworks of the universal heritage of our communities.



MSCI
ESG RATINGS

Sustainalytics

OUR STRATEGY FOR A SUSTAINABLE FUTURE:

Create value over time and be ready to successfully meet the future challenges

R&D



8
R&D dept.



>19 MLN
Yearly R&D investments



> 180
Patents



> 150
R&D specialists

PRODUCTS



> 50.000
Laser sources produced



ISO 9001 e ISO 13485
Certifications



> 60
Quality & Regulatory specialists

PEOPLE



~25% under 30 years
~ +17% 2021 headcount
>2.000 employees



WELFARE at the heart of business projects.
Workspaces were renewed for several Group companies: employees well-being was increased and plants' energy efficiency as well



>33,000 HOURS
Training

ENVIRONMENT



2 Photovoltaic systems active in 21
4 New plants planned in 22



10%
Self-generated energy or from renewable sources



80s

Production of CO₂ lasers for dermatology, surgery and therapy

1981

Incorporation of **El.En.S.n.c**

90s

Development of short pulse Nd:YAG lasers for dentistry and minimally invasive surgery treatments

1990 - 1993

Incorporation of **Deka MELA S.r.l., Lasit S.p.A. e Cutlite Penta S.r.l.**

1998

Smartepil (Deka Mela S.r.l.) - first long pulse Nd:Yag laser for dermatology and hair removal

2000

El.En.S.p.A. listed on the italian stock market

2002

Smartlipo (Deka Mela S.r.l. **laserlipolisi**®: localized removal of adipose deposits with minimally invasive treatment

Acquisition of **Cynosure Inc.**

2003

Smartxide DOT® Therapy (Deka Mela S.r.l.) dermatological surgery, anti-aging treatments,removal of pigmented lesions and scars

Acquisition of **Asclepion GmbH**

2004

Acquisition of **Quanta System**

2005

Acquisition of **Asa**

Cynosure IPO on Nasdaq

2007

Incorporation of a JV in China: **Wuhan Penta Chutian Co. Ltd**

Incorporation of **Cutlite Do Brasil Alta Tecnologia Ltda**

2008

Mediostar XT (Asclepion GmbH) esthetics and hair removal.

Industrial sector El.En. – creation of the **BLADE RF CO₂ BLADE RF** laser sources family

Litho (Quanta System S.p.A.) surgical, treatment of kidney stones

2009

Plus RF (Cutlite Penta S.r.l.) with RF El.En. sources for metacrilate and wood cutting systems

Incorporation of **Esthelogue S.r.l.**

2010

Smartxide² (Deka Mela S.r.l.) laser system with CO₂ radio frequency (RF) laser sources for dermatological surgery and aesthetics

2011

Mediostar Next (Asclepion GmbH) esthetics, hair removal



2012

Monna Lisa Touch™ (Deka Mela S.r.l.) for the treatment of vaginal atrophy

Cyber (Quanta System S.p.A.) surgery, Lithotripsy and BPH

2013

Incorporation of second JV **Penta Laser Equipment (Wenzhou) Co.Ltd**

2015

Bolt (Penta Chutian e Wenzhou - China) enhanced system for laser metal cutting

Discovery Pico (Quanta System S.p.A.) tattoo and pigmented lesions removal and dermatological treatments

HIRO TT (ASA S.r.l.) painful pathologies of the muscle and skeleton

Fiber Plus (Cutlite Penta S.r.l.) first metal cutting laser system equipped with fiber laser source

2016

Motus AX with Moveo (Deka Mela S.r.l.) hair removal, removal of pigmented lesions

Juliet® (Asclepion GmbH) for the treatment of vaginal atrophy

Deka M.E.L.A.S.r.l. and Quanta System S.p.A. join their commercial brand names into **Reinassance®** for the Italian market

2017

Industrial sector **RF 1222** CO₂ RF laser source "The Big Boy"

2018

ONDA Coolwaves® (Deka Mela S.r.l.) the first microwaves technology system for body contouring

2019

The Chinese subsidiary Penta Laser Equipment (Wenzhou) Co.Ltd incorporates **Penta Laser Technology (Shangdong) Co.Ltd**

Acquisition by Quanta System of **Galli S.r.l.** a precision mechanical components manufacturing facility.

2020

Schwarzy (magnetotherapy) **Red Touch** (dermatology) **Again** (hair removal) **Dr.Arnold** (magnetotherapy)

2021

Lasit Laser Polska incorporated by Lasit in Poland

Glide (dermatology) **Chrome Laser Station** (dermatology)

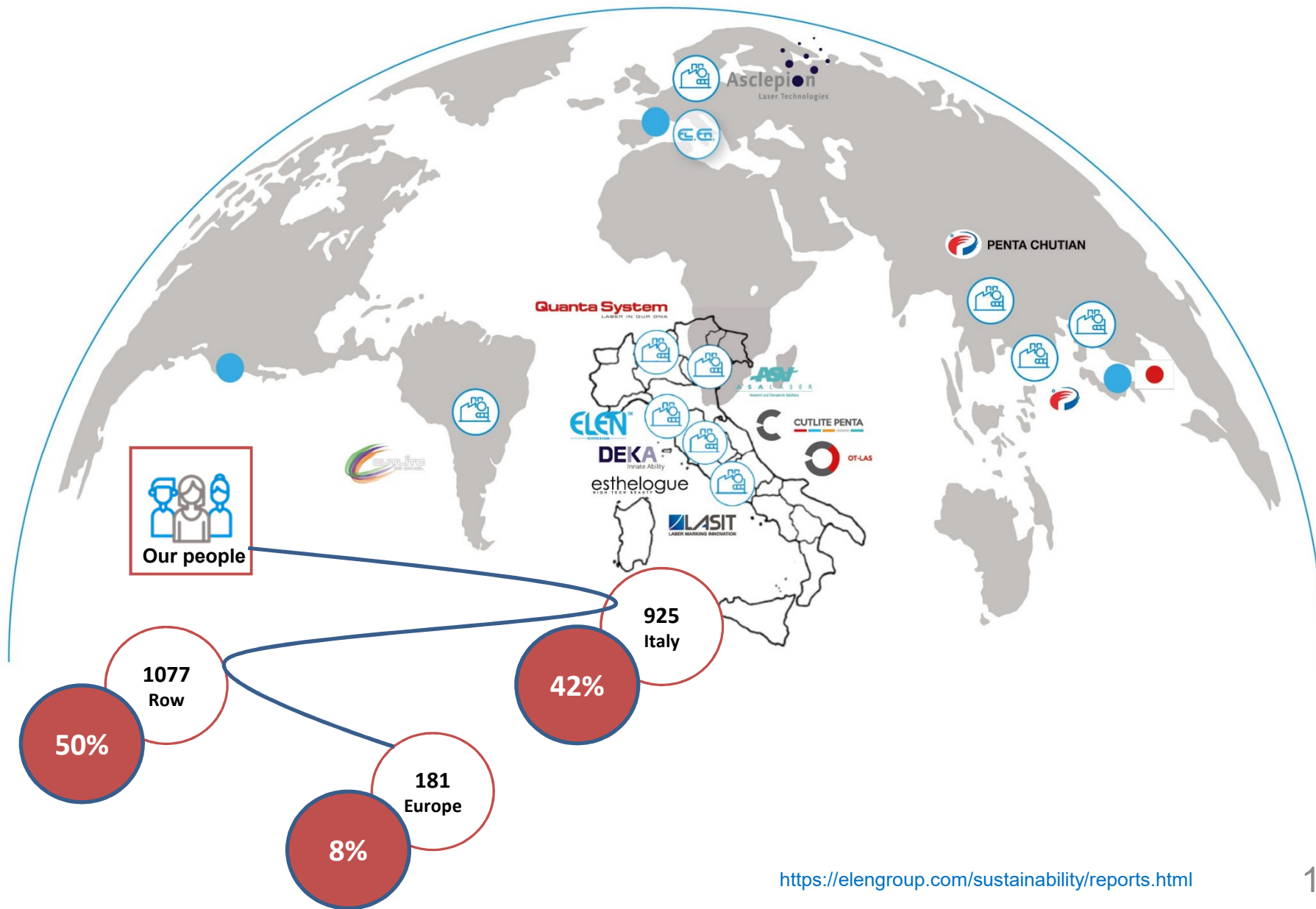



REVENUES

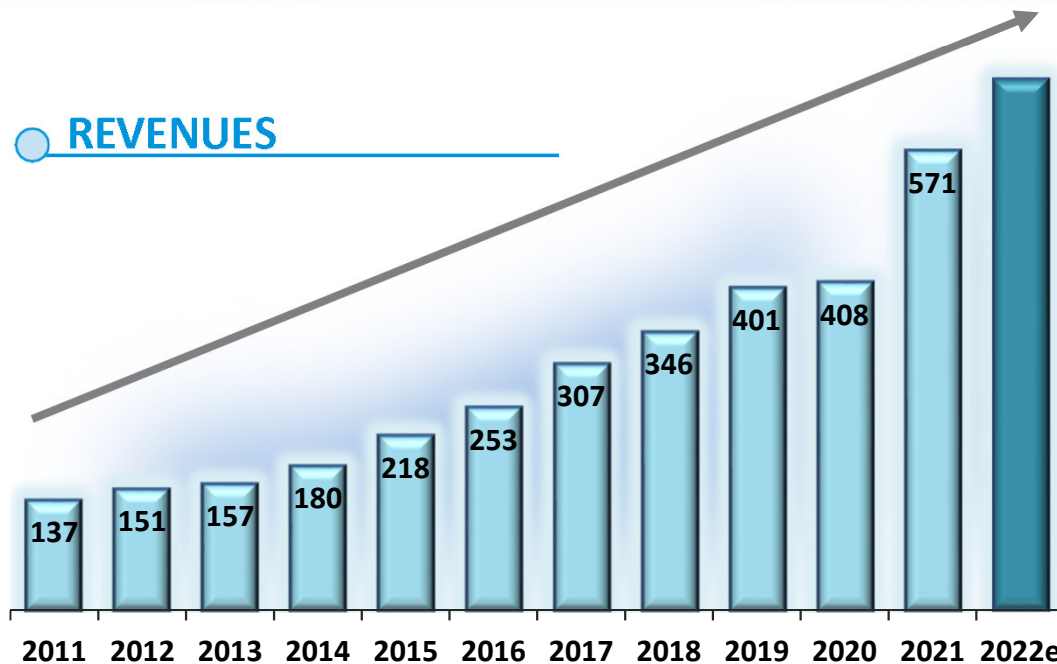

Cagr 11/21:
+15%

in Euro million

EBIT

Cagr 11/21:
+29%

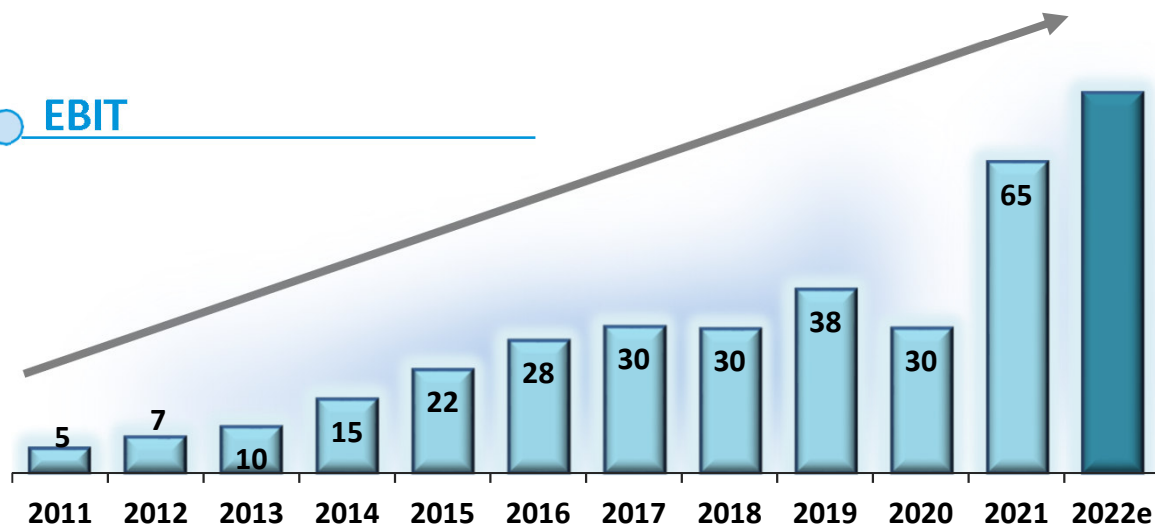

MARKETS AND GROWTH DRIVERS





MINIMALLY INVASIVE SURGERIES:

- ❖ Painless procedures
- ❖ Lower risks and side effects
- ❖ Shorter hospital stays/Faster recovery
- ❖ Savings by Private & National Health Systems
- ❖ Attractive ROI for surgical services providers



❖ Rapidly Growing Urology laser market

- Mordor intelligence: 5,51% 2019-2027 CAGR from \$1Bn in 2020



- ❖ Aging demographics and increasing focus on improving appearance and youthfulness;
- ❖ Growing interest in non-invasive or minimally invasive procedures and awareness of energybased aesthetic treatments
- ❖ Growing global obesity rate
- ❖ Reductions in procedure costs, attracting a broader patient base
- ❖ Normalization and social acceptance of cosmetic procedures

- ❖ Rapid growth expected:
 - ❖ Decision Market Reports CAGR 16,5% to 2027
 - ❖ Daniel Associates CAGR 10,23 to 2023
 - ❖ Fortune Business Insights CAGR 13,9 to 2027
 - ❖ Mordor Intelligence CAGR 11,08% to 2026





DEKA
Innate Ability

Asclepion
Laser Technologies

Quanta System
LASER IN OUR DNA

 **RENAISSANCE®**
The laser excellence



Laser cutting applications:

- Laser power increase + Cost reduction: enhanced flexibility, productivity and quality standards in manufacturing processes
- New application verticals
- Building and construction

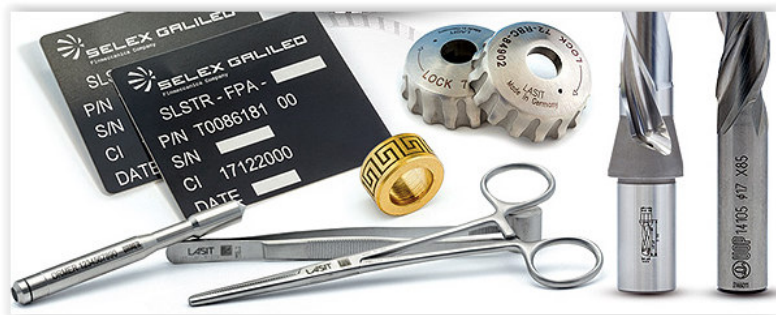

Laser marking:

- Products identification and traceability
- Minimal environmental impact

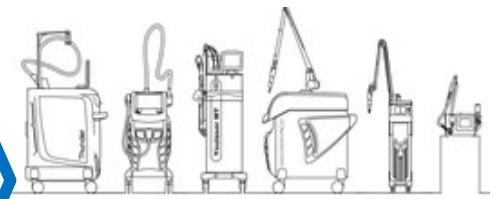
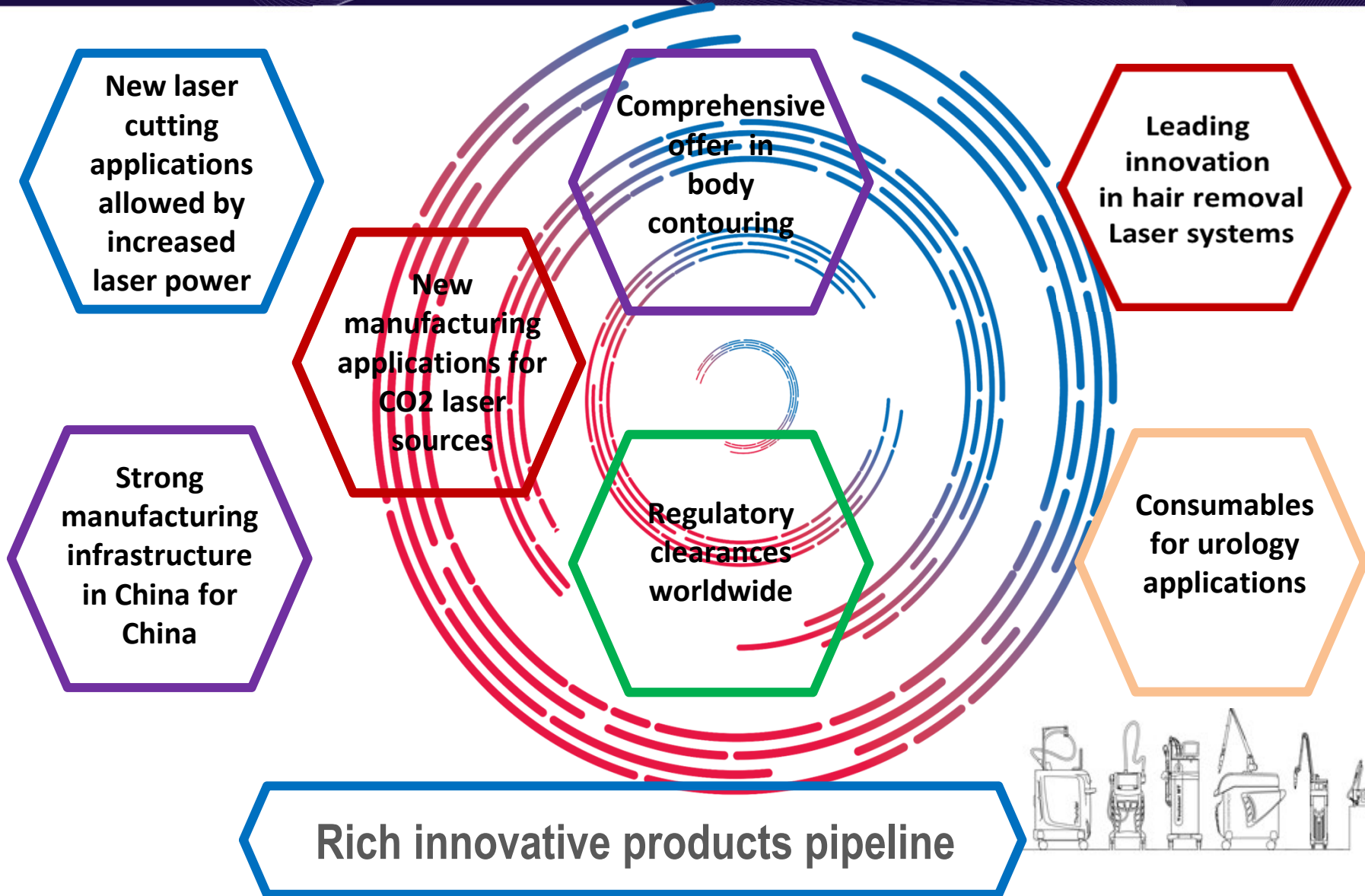

INNOVATION: PRODUCTS & APPLICATIONS

DEKA
Innate Ability

Asclepion
Laser Technologies

ASL
A S A L A S E R
Research and Therapeutic Solutions

esthelogue
HIGH TECH BEAUTY

Quanta System
LASER IN OUR DNA

 **PENTA CHUTIAN**

LASIT
LASER MARKING INNOVATION

 **CUTLITE**
100 BRASIL

 **CUTLITE PENTA**

 **OT-LAS**



Again



Motus



Thunder



Mediostar





DEKA
Innate Ability



esthelogue
HIGH TECH BEAUTY

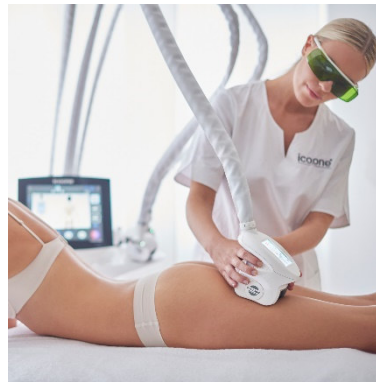

Asclepion
Laser Technologies





Discovery Pico Smart Pico

Unique high end system for laser tattoo removal

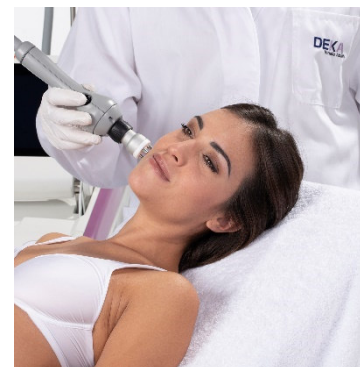

Luxea

The ultimate multi application and multi technology platform



RED Touch

The system for neocollagenesis and tissue regeneration





A complete line of Holmium lasers from 25 W to 155 W

FIBER DUST

One of the main worldwide players in high power medical fiber lasers

fiber
D U S T



New UHPTDL

Our novel disruptive technology for the most effective stones micro fragmentation

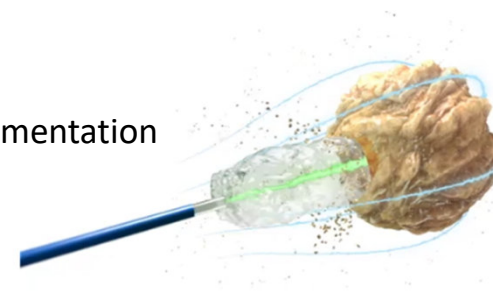



Novel CO₂ device for dermatology and gynecology featuring an additional 1540nm laser source



**MiS (MLS Family)**

For degenerative neuropathies





STEEL CUTTING

>12 kW Average power in 2022 sales

40 kW systems installed in 2022

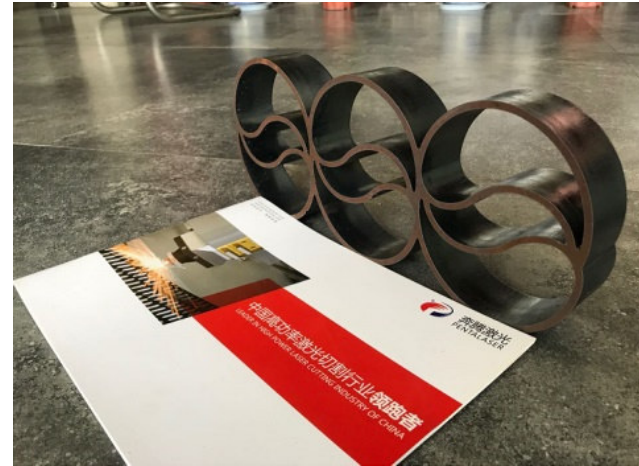
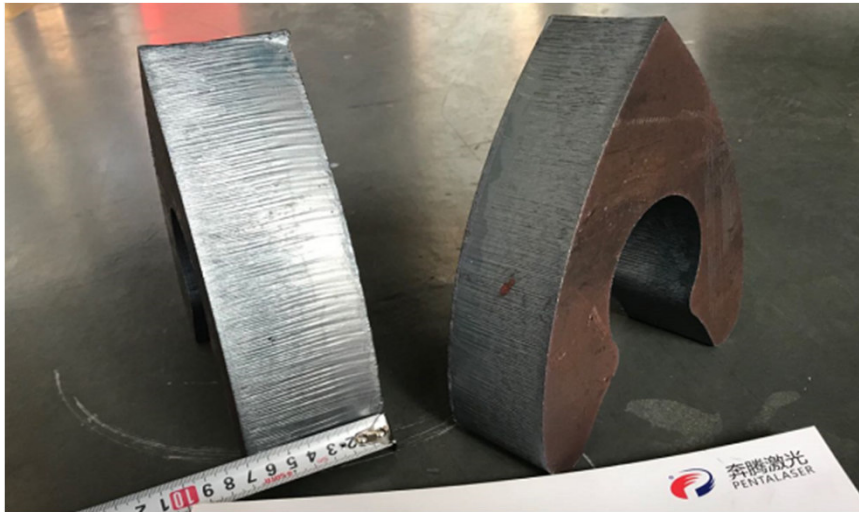

PENTALASER 奔腾激光
LASER CUTTING & WELDING EXPERT

五、压力容器行业技术渗透

奔腾激光
为封头生产企业提供全套激光解决方案

400 0587 567





一、高功率激光切割机床的技术创新

Technical innovation of high power laser cutting machine tools



飞越6 (SwingVI) 的技术创新 Tech. innovation on Swing VI

特点: feature

设计定位 Design orientation:

1. 最经济可靠的高功率激光机床;
1. The most economical and reliable high-power laser machine tools
2. 意大利CNC, 德国普雷切割头;
2. Italy CNC, Germany cutting head;
3. 独一无二的高功率切割工艺;
3. Unique high power cutting technology;
4. 大众定价: 130-320万元 (12-30kW)
4. Pricing: 1.3 million to 3.2 million yuan (12-30kW)。

经济实用,
Economical and practical,

牛年热销!
hot sale

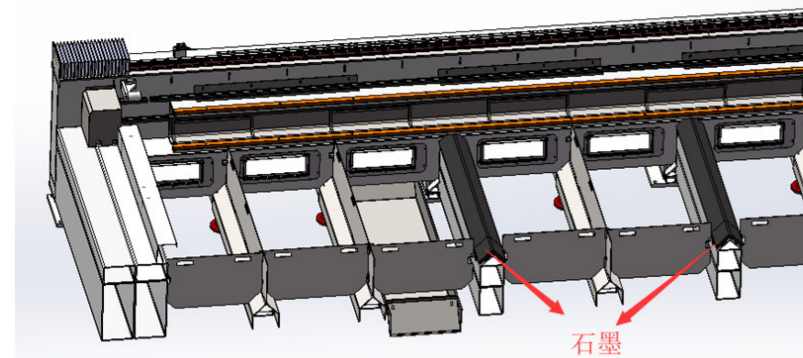
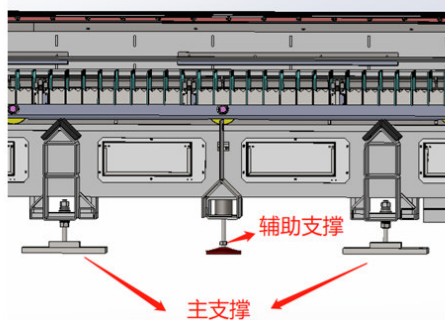

FINANCIAL HIGHLIGHTS





	Euro '000	30/09/21	%	30/09/22	%	Var. %
		unaudited		unaudited		
Medical		220.476	54,4%	270.529	55,9%	22,7%
Industrial		184.824	45,6%	213.820	44,1%	15,7%
Revenues		405.300	100,0%	484.348	100,0%	19,5%
Gross margin		150.203	37,1%	179.496	37,1%	19,5%
Operating Expenses		33.984	8,4%	41.511	8,6%	22,1%
Staff expenses		60.556	14,9%	70.421	14,5%	16,3%
EBITDA		55.663	13,7%	67.564	13,9%	21,4%
Depr., amort., accruals		11.086	2,7%	9.640	2,0%	-13,0%
EBIT		44.577	11,0%	57.924	12,0%	29,9%
Net financ.income(charges)		1.156	0,3%	(7)	0,0%	
Other income (expense) net		(171)	0,0%	3	0,0%	
EBT		45.562	11,2%	57.920	12,0%	27,1%

	31/12/21	30/09/22
		unaudited
Net financial position	115.766	32.007

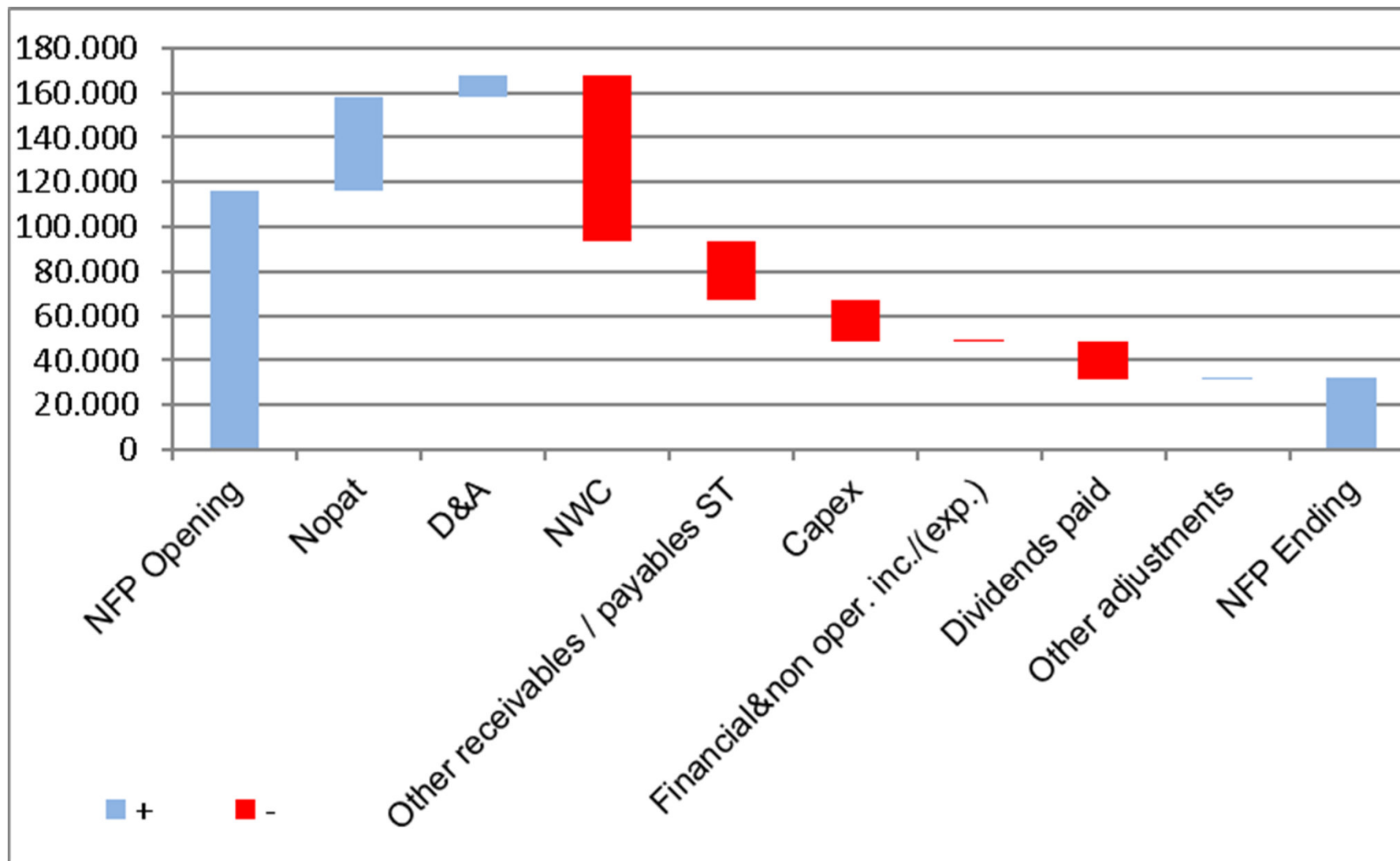

(*) 19 mln= 16 capex + 3 medium/long - term cash investment



Medical: +23%

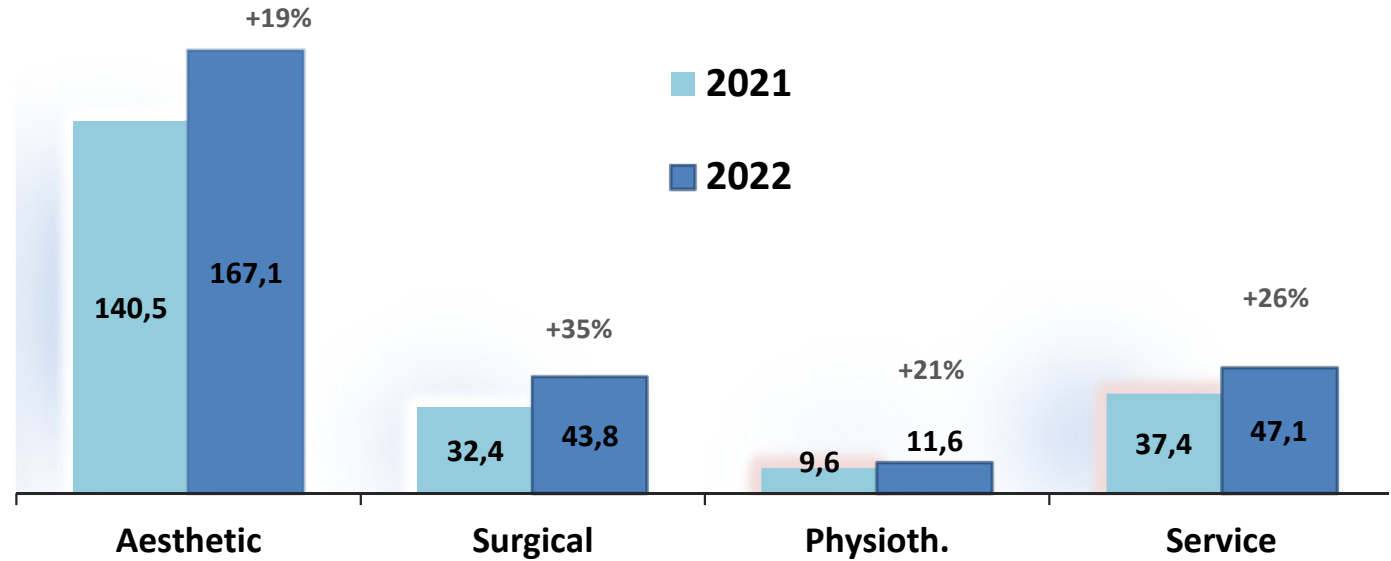

+16%

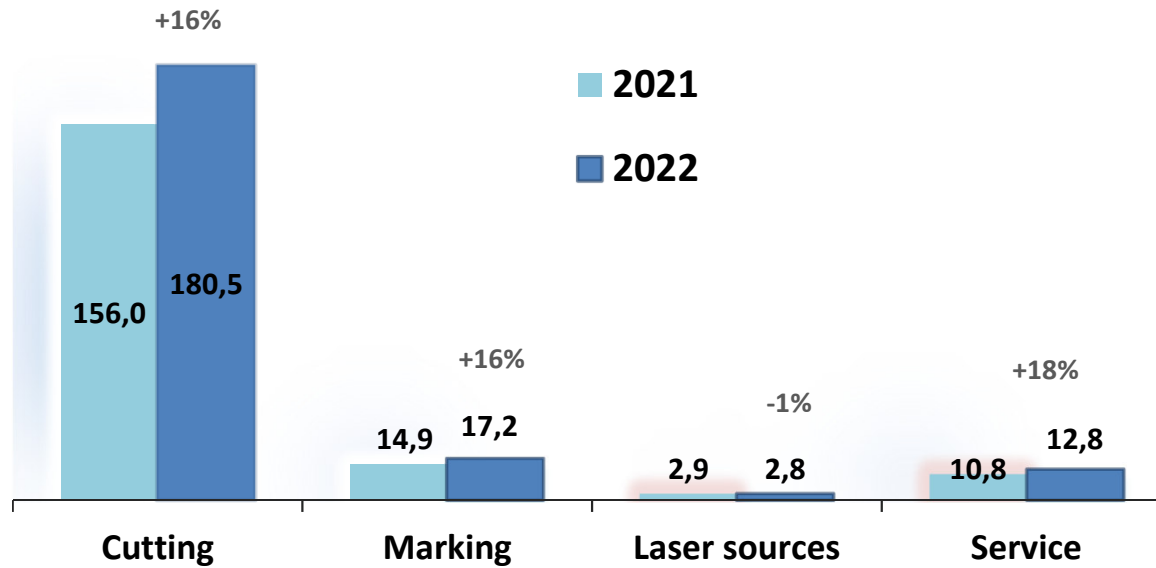

in Euro million

Industrial: +16%

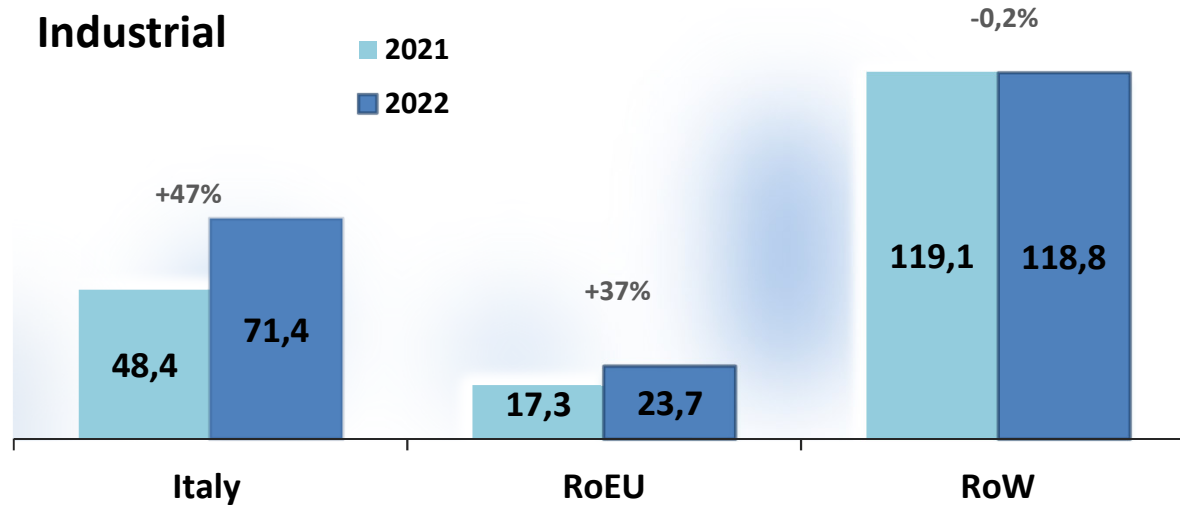
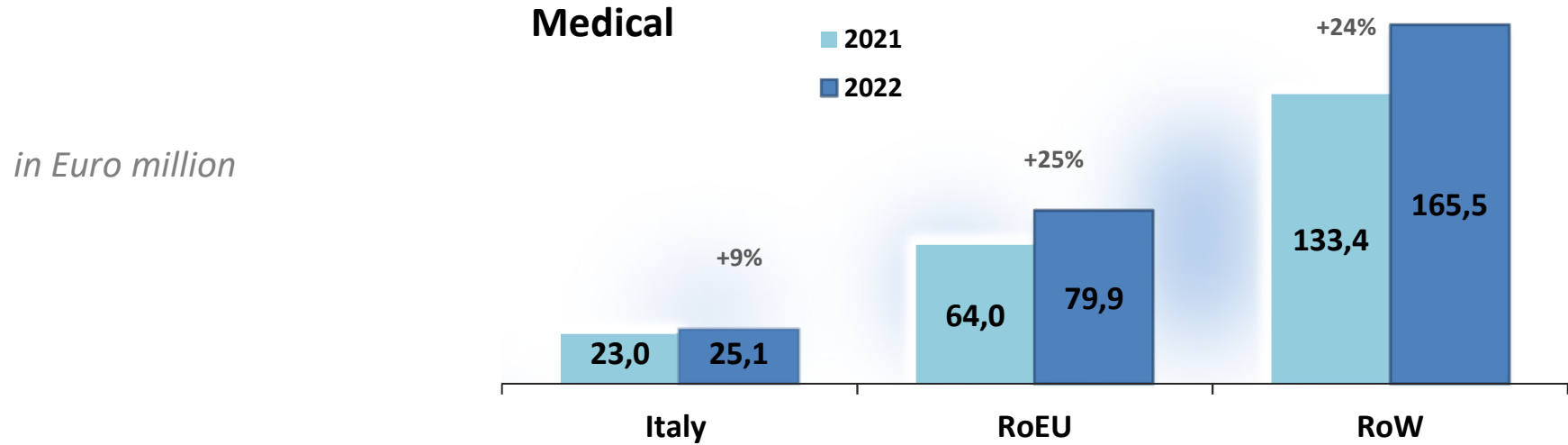

CURRENT OUTLOOK

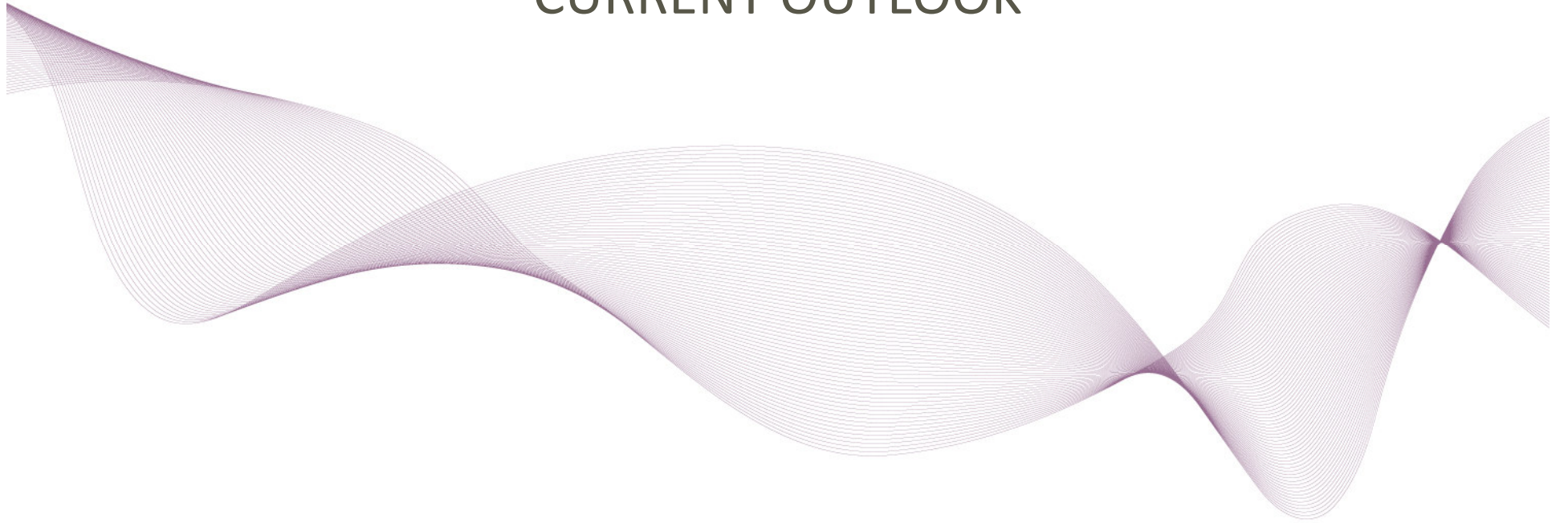



MULTIPLES & COMPARABLES





Stockholder's Equity per share	4,0
Price / Book Value Adj.	3,5
EV / EBIT (90% EBIT)	15,0
EV / Sales (90% Sales)	1,8

El.En. Market Cap.	1.095,1 @ € 13,72
Net financial position	32,0 @ 30/09/22
Financial investments m/l term	21,4 @ 30/09/22
Enterprise Value	1.041,7



Sept. 30th, 2022

	Price	Revenue	Var.% Rev.	EBIT	EBIT%	MK.Cap.	EV	EV/Sales (*)	EV/EBIT (*)	P/Book Value
Medical/Aesthetic										
Cutera	\$44,49	\$185	27%	\$(33)	-18%	\$871	\$935	3,8	n.a.	56,2
InMode	\$37,52	\$321	30%	\$138	43%	\$3.120	\$2.637	6,2	14,4	6,1
Venus	\$0,22	\$75	3%	\$(26)	-35%	\$15	\$85	0,9	n.a.	1,6
Sisram Medical (2)	\$1,03	\$175	39%	\$24	14%	\$480	\$371	1,1	7,7	1,2
Lutronic (2)	€ 13,32	€ 89	54%	€ 19	21%	€ 355	€ 299	1,7	7,9	3,5
Industrial										
IPG Photonics Co.	\$94,63	\$1.096	0%	\$258	24%	\$4.610	\$3.478	2,4	10,1	1,8
Prima Industrie	€ 24,70	€ 327	15%	€ 14	4%	€ 259	€ 339	0,8	18,8	1,4
Han's Laser	¥26,92	¥10.490	-12%	¥538	5%	¥28.640	¥28.906	2,1	40,4	2,0
Bystronic (2)	CHF 651	CHF 453	3%	CHF 11	2%	CHF 1.190	CHF 750	0,8	35,7	1,7
El.En. (1)	€ 13,72	€ 484	20%	€ 58	12%	€ 1.095	€ 1.042	1,8	15,0	3,5

(1) EV and multiples as for previous slide

(2) Financials on June 30th, 2022

(*) Revenue, Ebit and earnings annualized

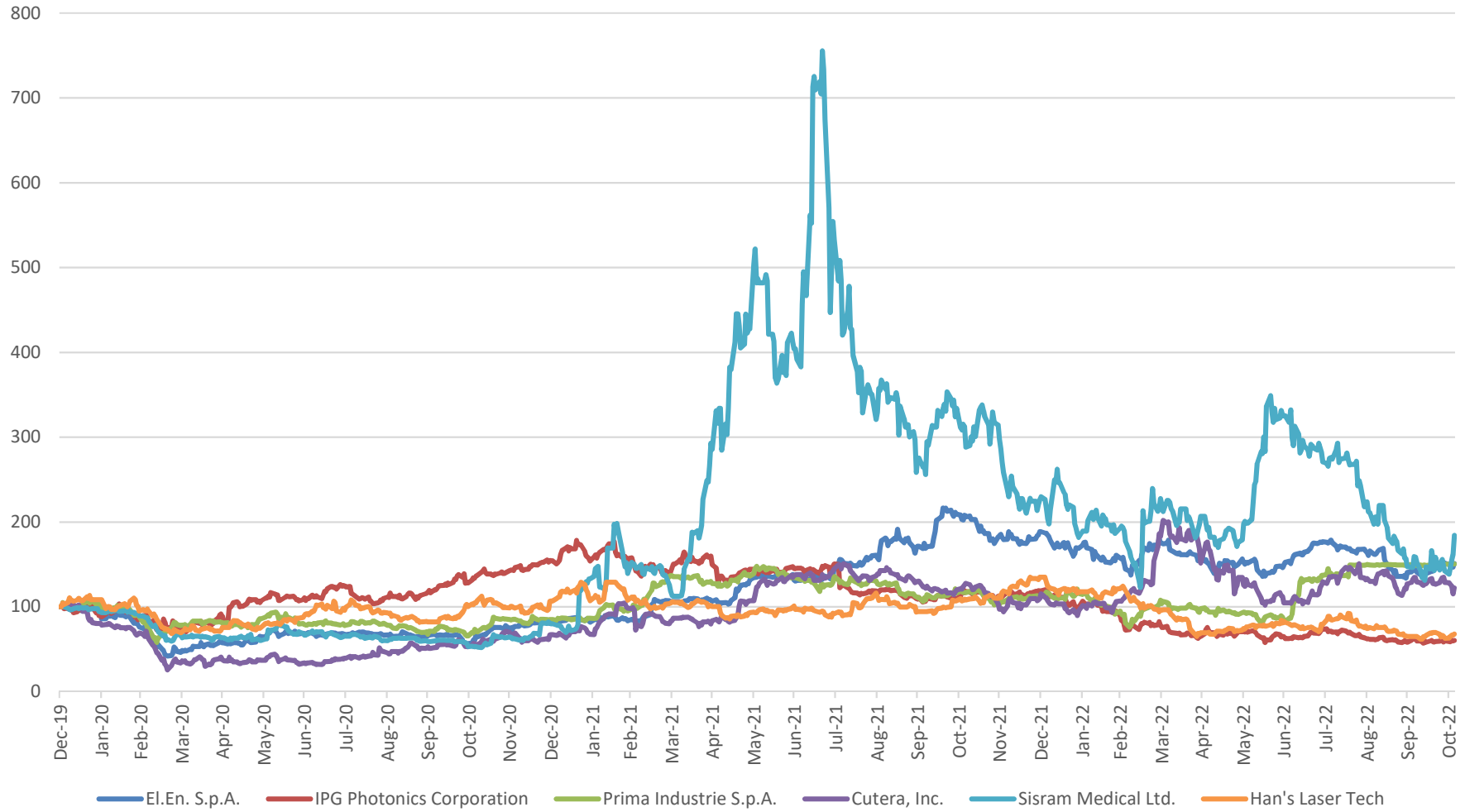



CONTACTS

El.En. S.P.A.

Enrico Romagnoli

Investor Relations Manager

tel. +39 055-8826807

E-mail: finance@elen.it

POLYTEMS HIR

Financial Communication, IR and Press Office

Bianca Fersini Mastelloni - b.fersini@polytemshir.it

Silvia Marongiu - s.marongiu@polytemshir.it

Tel. +39 06-69923324