



## COMPANY PRESENTATION

# INTERMONTE NORDICS DIGITAL CONFERENCE

May 16<sup>th</sup> , 2023



Member of  
**Euronext  
Tech Leaders**

EURONEXT  
Tech Leaders

EURONEXT



Certain statements in this slide show, including those addressing the Company's beliefs, plans, objectives, estimates or expectations of possible future results or events, are forward-looking statements. Forward-looking statements involve known or unknown risks, including general economic and business conditions, and conditions in the industry we operate and may be affected should our assumptions turn out to be inaccurate. Consequently, no forward-looking statement can be guaranteed and actual future results, performance, or achievements may vary materially from those expressed or implied by such forward-looking statements. The Company undertakes no obligation about the contents nor to update the forward-looking statements to reflect events or circumstances that may arise after the date hereof.





1. Overview
2. Markets and Growth drivers
3. Innovation: products & applications
4. FDA clearance for Accure laser
5. Financial Highlights
6. Current Outlook
7. Multiples & Comparables

# OVERVIEW





## A PRIMARY PLAYER PROVIDING MEDICAL, INDUSTRIAL AND CONSERVATION LASER SOLUTIONS WORLDWIDE



### **World Class Hi-Tech company**

Hi-Tech industrial group providing laser solutions with proprietary technologies and know how developed over 40 years



Listed on Milan's Stock Exchange Star segment since year 2000 and member of Euronext Tech Leaders



### **Within Worldwide leaders in its space**

Active worldwide on several laser application segments and markets...



...progressively widening its worldwide presence achieving continuous growth over the years



>40

YEARS OF EXPERIENCE



>20

SUBSIDIARIES

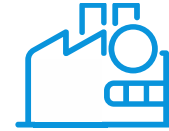

8

COUNTRIES WITH  
DIRECT PRESENCE



13

PLANTS

## WE CREATE LIGHT, ENERGY, WAVES



### MEDICAL

Our energy based systems improve people's well-being and life quality.

In the **SURGICAL SECTOR**, our minimally invasive technology systems minimize pain, side effects and risks of surgical procedures and hospitalization days.

In the **AESTHETIC SECTOR**, our systems satisfy the growing desire of individuals to improve their appearance also reducing pathological or painful imperfections.



### INDUSTRIAL

Our **LASER CUTTING** and **MARKING SYSTEMS** Improve the productivity of our customers manufacturing plants also limiting the environmental impact of manufacturing processes minimizing waste, fumes generated by the process, use of chemical additives, and allowing to eliminate the need for inks, solvents or glues within the process.



### CONSERVATION

Our **LASER SYSTEMS PRESERVE** artworks of the universal heritage of our communities.



**MSCI**  
ESG RATINGS

Sustainalytics

## OUR STRATEGY FOR A SUSTAINABLE FUTURE:

Create value over time and be ready to successfully meet the future challenges

### R&D



**8**  
R&D dept.



**>19 MLN**  
Yearly R&D investments



**> 280**  
Patents



**> 180**  
R&D specialists

### PRODUCTS



**> 50.000**  
Laser sources produced



**ISO 9001 e ISO 13485**  
Certifications



**> 60**  
Quality & Regulatory specialists

### PEOPLE



**~25%** under 30 years  
**~ +11%** 2021 headcount  
**>2.100** employees



**WELFARE** at the heart of business projects.  
Workspaces were renewed for several Group companies: employees well-being was increased and plants' energy efficiency as well



**>39,000 HOURS**  
Training

### ENVIRONMENT



**2** Photovoltaic systems active in 21  
**4** New plants installed in 22



**9%**  
Self-generated energy or from renewable sources



80s

Production of CO<sub>2</sub> lasers for dermatology, surgery and therapy

1981

Incorporation of **El.En.S.n.c**

90s

Development of short pulse Nd:YAG lasers for dentistry and minimally invasive surgery treatments

1990 - 1993

Incorporation of **Deka MELA S.r.l., Lasit S.p.A. e Cutlite Penta S.r.l.**

1998

**Smartepil** (Deka Mela S.r.l.) - first long pulse Nd:Yag laser for dermatology and hair removal

2000

**El.En.S.p.A.** listed on the italian stock market

2002

**Smartlipo** (Deka Mela S.r.l. **laserlipolisi**®: localized removal of adipose deposits with minimally invasive treatment

Acquisition of **Cynosure Inc.**

2003

**Smartxide DOT**® Therapy (Deka Mela S.r.l.) dermatological surgery, anti-aging treatments,removal of pigmented lesions and scars

Acquisition of **Asclepion GmbH**

2004

Acquisition of **Quanta System**

2005

Acquisition of **Asa**

**Cynosure** IPO on Nasdaq

2007

Incorporation of a JV in China: **Wuhan Penta Chutian Co. Ltd**

Incorporation of **Cutlite Do Brasil Alta Tecnologia Ltda**

2008

**Mediostar XT** (Asclepion GmbH) esthetics and hair removal.

Industrial sector El.En.– creation of the **BLADE RF CO<sub>2</sub> BLADE RF** laser sources family

**Litho** (Quanta System S.p.A.) surgical, treatment of kidney stones

2009

**Plus RF** (Cutlite Penta S.r.l.) with RF El.En. sources for metacrilate and wood cutting systems

Incorporation of **Esthelogue S.r.l.**

2010

**Smartxide<sup>2</sup>** (Deka Mela S.r.l.) laser system with CO<sub>2</sub> radio frequency (RF) laser sources for dermatological surgery and aesthetics

2011

**Mediostar Next** (Asclepion GmbH) aesthetics, hair removal





2012

**Monna Lisa Touch™** (Deka Mela S.r.l.) for the treatment of vaginal atrophy

**Cyber** (Quanta System S.p.A.) surgery, Lithotripsy and BPH

2013

Incorporation of second JV **Penta Laser Equipment (Wenzhou) Co.Ltd**

2015

**Bolt** (Penta Chutian e Wenzhou - China) enhanced system for laser metal cutting

**Discovery Pico** (Quanta System S.p.A.) tattoo and pigmented lesions removal and dermatological treatments

**HIRO TT** (ASA S.r.l.) painful pathologies of the muscle and skeleton

**Fiber Plus** (Cutlite Penta S.r.l.) first metal cutting laser system equipped with fiber laser source

2016

**Motus AX** with Moveo (Deka Mela S.r.l.) hair removal, removal of pigmented lesions

**Juliet®** (Asclepion GmbH) for the treatment of vaginal atrophy

Deka M.E.L.A.S.r.l. and Quanta System S.p.A. join their commercial brand names into **Renaissance®** for the Italian market

2017

Industrial sector **RF 1222** CO<sub>2</sub> RF laser source "The Big Boy"

2018

**ONDA Coolwaves®** (Deka Mela S.r.l.) the first microwaves technology system for body contouring

2019

The Chinese subsidiary Penta Laser Equipment (Wenzhou) Co.Ltd incorporates **Penta Laser Technology (Shangdong) Co.Ltd**

Acquisition by Quanta System of **Galli S.r.l.** a precision mechanical components manufacturing facility.

2020

**Schwarzy** (magnetotherapy) **Red Touch** (dermatology) **Again** (hair removal) **Dr.Arnold** (magnetotherapy)

2021

**Lasit Laser Polska** incorporated by Lasit in Poland

**Glide** (dermatology) **Chrome Laser Station** (dermatology)

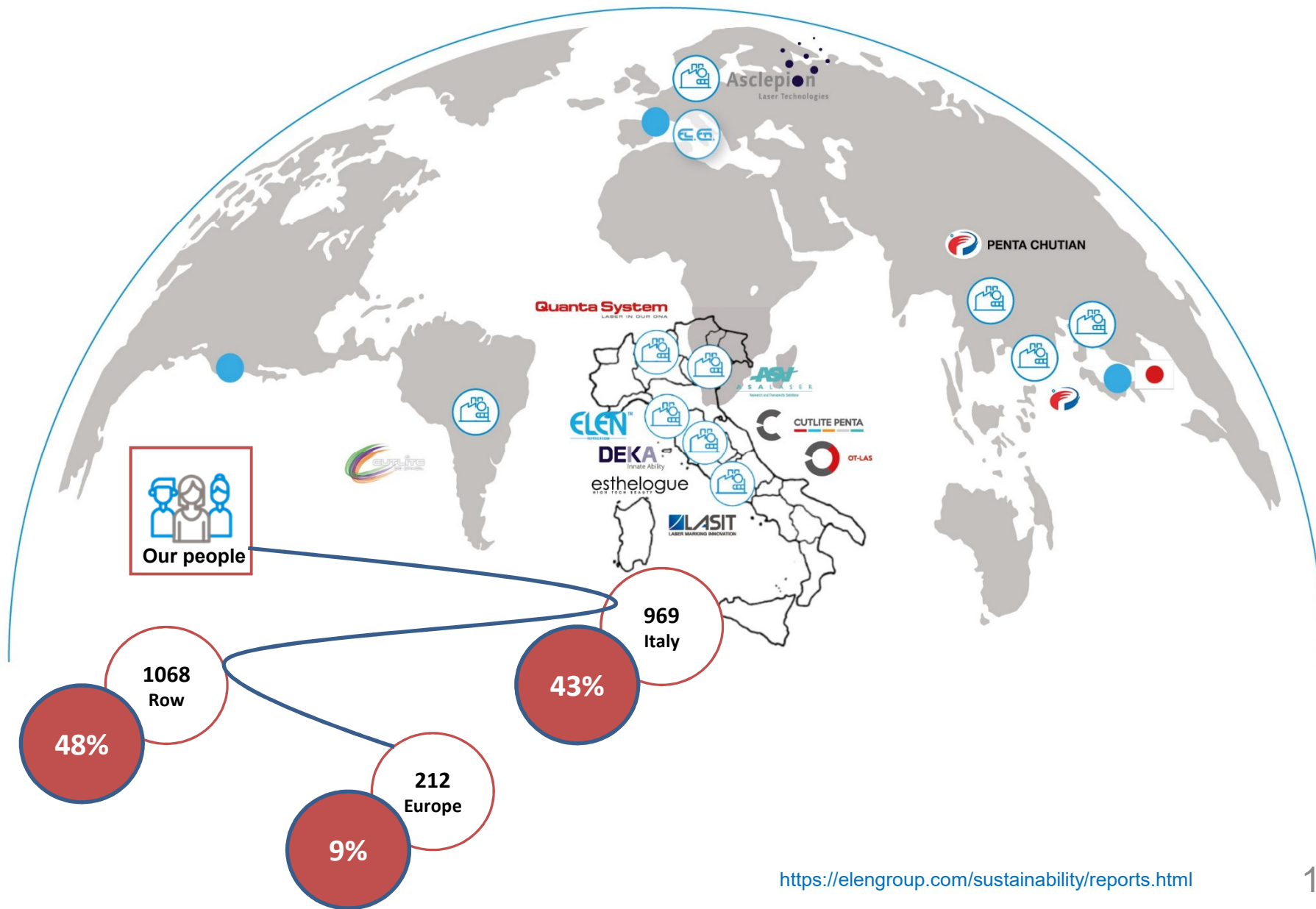



REVENUES

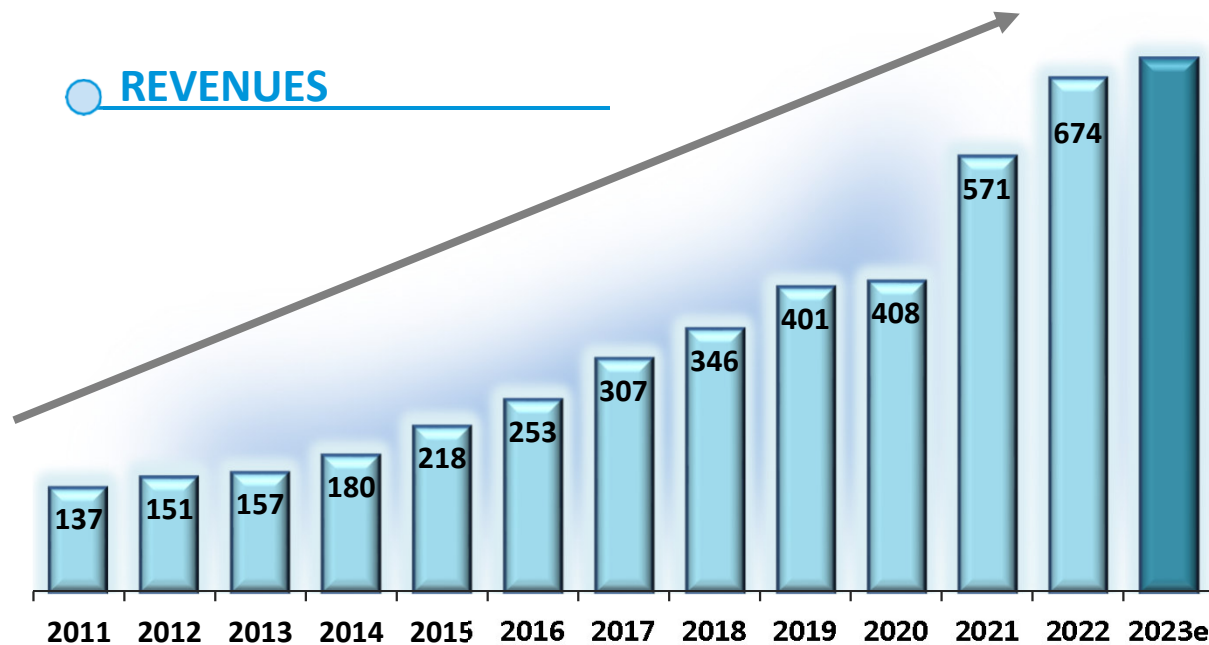

Cagr 11/22:  
+14%

*in Euro million*

EBIT

Cagr 11/22:  
+26%

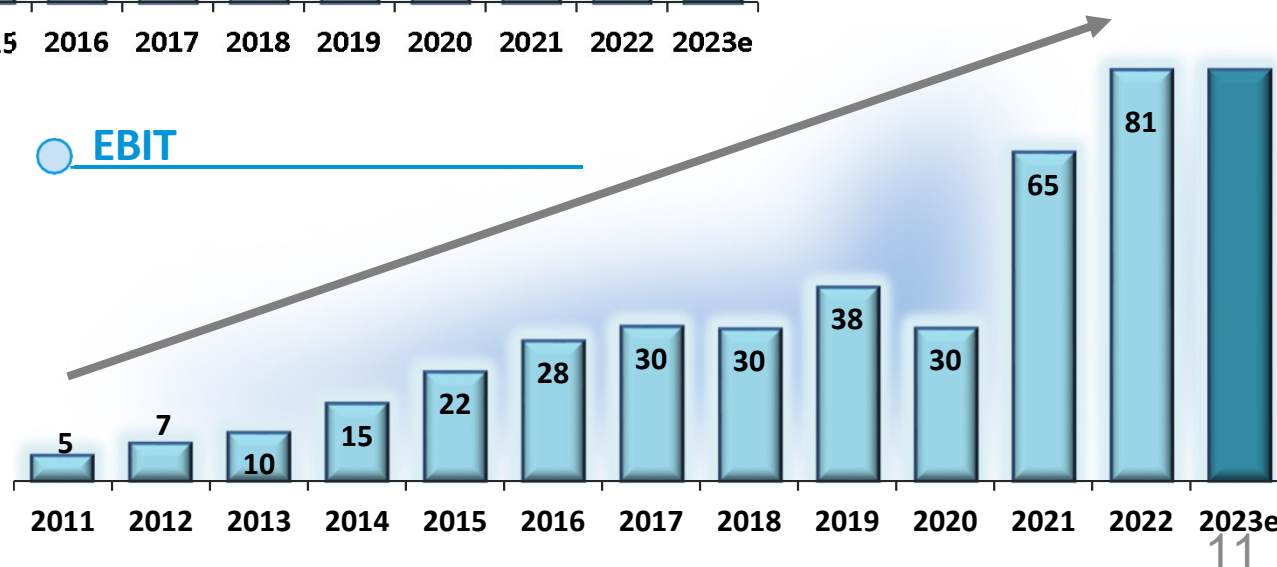

# MARKETS AND GROWTH DRIVERS





## MINIMALLY INVASIVE SURGERIES:

- ❖ Painless procedures
- ❖ Lower risks and side effects
- ❖ Shorter hospital stays/Faster recovery
- ❖ Savings by Private & National Health Systems
- ❖ Attractive ROI for surgical services providers
- ❖ Rapidly Growing Urology laser market





- ❖ Aging demographics and increasing focus on improving appearance and youthfulness;
- ❖ Growing interest in non-invasive or minimally invasive procedures and awareness of energybased aesthetic treatments
- ❖ Growing global obesity rate
- ❖ Reductions in procedure costs, attracting a broader patient base
- ❖ Normalization and social acceptance of cosmetic procedures
- ❖ Rapid growth expected





**GLOBAL MEDICAL LASER MARKET**

- ❖ Mordor Intelligence CAGR 13,4% to 2028
- ❖ Fortune business insight CAGR 16,8% to 2029
- ❖ Global Market Insights CAGR 14,5% to 2032
- ❖ Research and Markets CAGR 13,2% to 2030

With an estimated market size of  $\approx$  \$5 Bln in 2021 including:

- ❖ Ophthalmology
- ❖ Dermatology
- ❖ Aesthetics
- ❖ Surgical
- ❖ Gynecology - Urology
- ❖ Cardiovascular
- ❖ Dentistry

**EXPECTED GROWTH IN COSMETIC MARKET**

- ❖ Research and Markets CAGR 15,2% to 2027
- ❖ The business research company CAGR 19,1% to 2027





**DEKA**  
Innate Ability

**Asclepion**  
Laser Technologies

**Quanta System**  
LASER IN OUR DNA

 **RENAISSANCE®**  
The laser excellence





## Laser cutting applications:

- Laser power increase + Cost reduction: enhanced flexibility, productivity and quality standards in manufacturing processes
- New application verticals
- Building and construction



## Laser marking:

- Products identification and traceability
- Minimal environmental impact

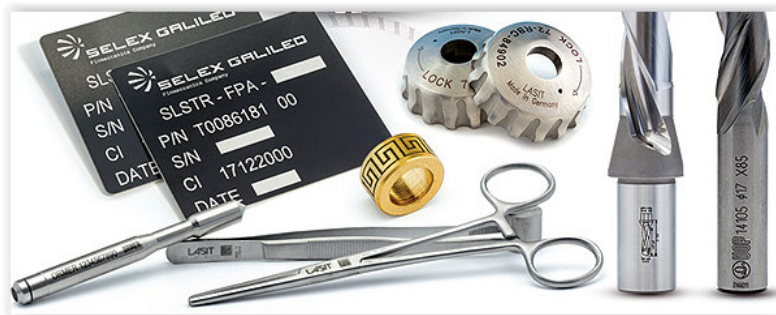

## Laser processing market:

- Size: \$17,48 billion in 2021
- Expected CAGR to 2030: 9,1%

# INNOVATION: PRODUCTS & APPLICATIONS

**DEKA**  
Innate Ability

**Asclepion**  
Laser Technologies

**ASL**  
A S A L A S E R  
Research and Therapeutic Solutions

**esthelogue**  
HIGH TECH BEAUTY

**Quanta System**  
LASER IN OUR DNA

 **PENTA CHUTIAN**

**LASIT**  
LASER MARKING INNOVATION

 **CUTLITE**  
100 BRASIL

 **CUTLITE PENTA**

 **OT-LAS**



Again



Motus



Thunder



Mediostar





---

**DEKA**  
Innate Ability



**esthelogue**  
HIGH TECH BEAUTY

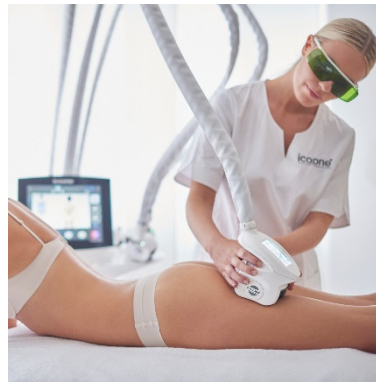

---

**Asclepion**  
Laser Technologies





**Discovery Pico Smart Pico**

Unique high end system for laser tattoo removal

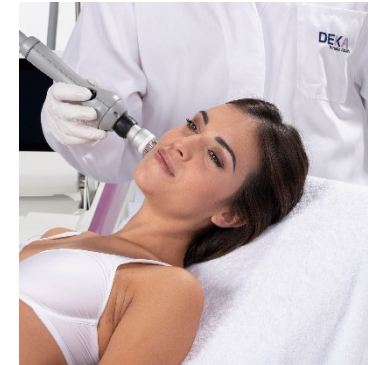

**Luxea**

The ultimate multi application and multi technology platform



**RED Touch**

The system for neocollagenesis and tissue regeneration





A complete line of Holmium lasers from 25 W to 155 W

### FIBER DUST

One of the main worldwide players in high power medical fiber lasers

fiber  
D U S T



## New UHPTDL

Our novel disruptive technology for the most effective stones micro fragmentation

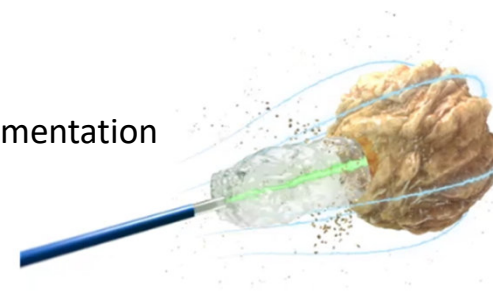



**Novel CO<sub>2</sub> device** for dermatology and gynecology featuring an additional 1540nm laser source



**MiS (MLS Family)**

For degenerative neuropathies







**STEEL CUTTING**

>12 kW Average power in 2022 sales

**40 kW systems installed in 2022**

**Testing 60kw systems**

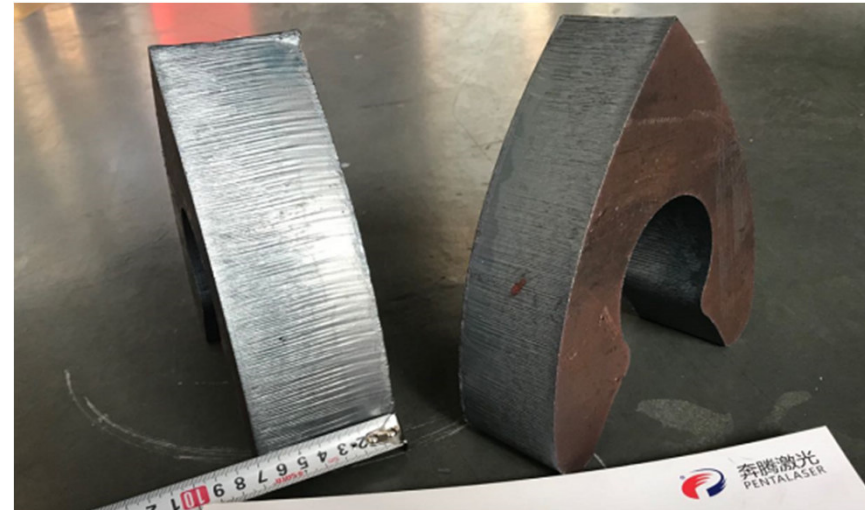

PENTALASER 奔騰激光  
LASER CUTTING & WELDING EXPERT

五、压力容器行业技术渗透

奔騰激光 PENTALASER  
为封头生产企业提供全套激光解决方案

400 0587 567





## 一、高功率激光切割机床的技术创新

### Technical innovation of high power laser cutting machine tools



#### 飞越6 (SwingVI) 的技术创新 Tech. innovation on Swing VI

特点: feature

#### 设计定位 Design orientation:

1. 最经济可靠的高功率激光机床;  
1.The most economical and reliable high-power laser machine tools
2. 意大利CNC, 德国普雷切割头;  
2. Italy CNC, Germany cutting head;
3. 独一无二的高功率切割工艺;  
3. Unique high power cutting technology;
4. 大众定价: 130-320万元 (12-30kW)  
4.Pricing: 1.3 million to 3.2 million yuan (12-30kW)。

经济实用,  
Economical and practical,

牛年热销!  
hot sale

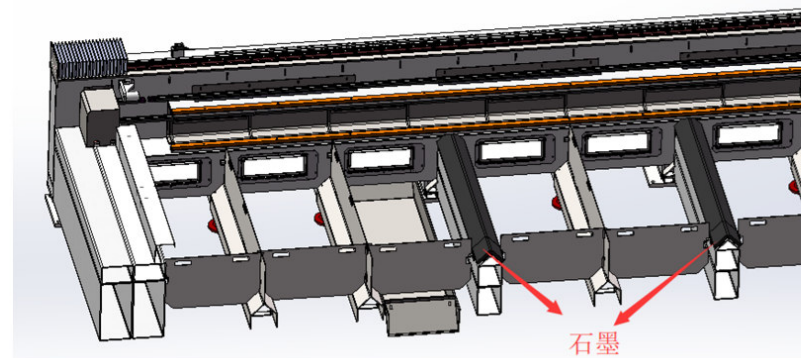
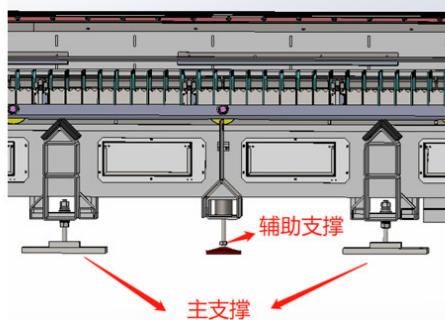

# FDA CLEARANCE FOR ACCURE LASER





- Disruptive technology with active IP portfolio in the vast, global acne market
- Positive safety profile & clinical results; non-drug based with expected durable outcomes
- World-class team: Dr. Rox Anderson: Co-Founder; Chief Scientific & Medical Officer
- CE Marked





Targeting Sebaceous Glands: "the key to a durable solution"<sup>1</sup>



Sebaceous Glands: Central to Pathogenesis of Acne

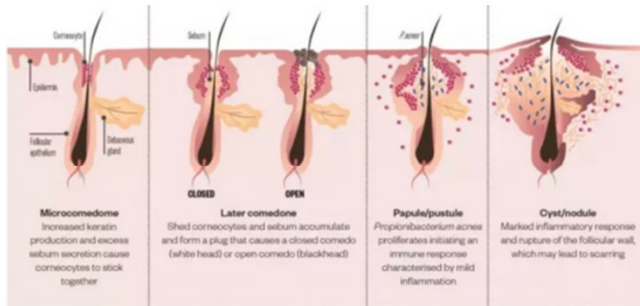

Figure 1: Acne pathogenesis<sup>2</sup>

"In particular, the sebaceous gland plays an exquisite role in the initiation of the disease (acne) as it possesses all the enzyme machinery for the production of hormones and cytokines."<sup>3</sup>

Unique Properties of Laser

	Laser light	Non-laser light (e.g., flashlight)
①	Monochromatic 	Polychromatic 
②	Coherent 	Incoherent 
③	Collimated 	Divergent 
④	High intensity	Low intensity

4

Provide for Selective Targeting

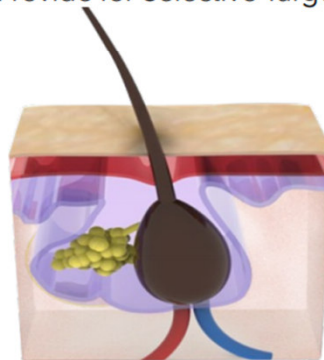

11

1726nm is Optimal Wavelength

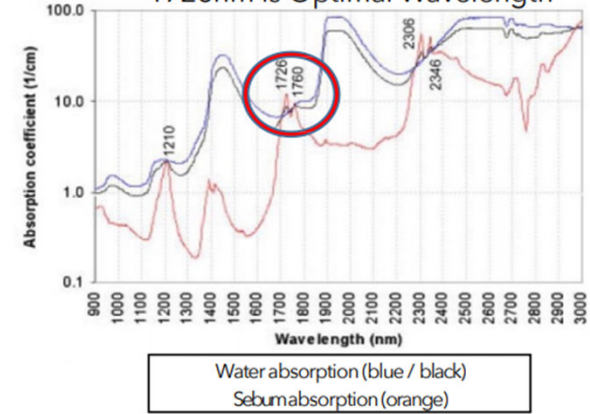

"Unlike other existing laser and light options for acne treatment, however, **Accure** is the first light-based platform to selectively target and injure sebaceous glands, the main source of sebum production and the key to a durable solution for acne."<sup>1</sup>

Treatment with novel laser in acne studies targets sebaceous glands



1. <https://www.mdedge.com/dermatology/article/247967/acne/treatment-novel-laser-acne-studies-targets-sebaceous-glands>  
 2. <https://pharmaceutical-journal.com/article-feature/innovation-in-acne-treatment-is-long-overdue-but-the-treatment-pipeline-looks-promising>  
 3. <https://www.mdedge.com/dermatology/article/247967/acne/treatment-novel-laser-acne-studies-targets-sebaceous-glands>  
 4. <https://link.springer.com/book/10.1007/978-981-15-6556-4>



Durability

24 Months



Images courtesy Dr. Tanghetti

# FINANCIAL HIGHLIGHTS





	Euro '000	31/12/21	%	31/12/22	%	Var. %
Medical		311.290	54,5%	382.063	56,7%	22,7%
Industrial		260.112	45,5%	291.518	43,3%	12,1%
<b>Revenues</b>		<b>571.402</b>	<b>100,0%</b>	<b>673.581</b>	<b>100,0%</b>	<b>17,9%</b>
<b>Gross margin</b>		<b>212.073</b>	<b>37,1%</b>	<b>249.695</b>	<b>37,1%</b>	<b>17,7%</b>
Operating Expenses		47.812	8,4%	56.250	8,4%	17,6%
Staff expenses		84.170	14,7%	98.194	14,6%	16,7%
<b>EBITDA</b>		<b>80.091</b>	<b>14,0%</b>	<b>95.251</b>	<b>14,1%</b>	<b>18,9%</b>
Depr., amort., accruals		15.234	2,7%	14.250	2,1%	-6,5%
<b>EBIT</b>		<b>64.858</b>	<b>11,4%</b>	<b>81.001</b>	<b>12,0%</b>	<b>24,9%</b>
Net financ.income(charges)		1.752	0,3%	(1.934)	-0,3%	
Other income (expense) net		(185)	0,0%	(79)	0,0%	-57,5%
<b>EBT</b>		<b>66.424</b>	<b>11,6%</b>	<b>78.988</b>	<b>11,7%</b>	<b>18,9%</b>
Income taxes		17.300	3,0%	19.953	3,0%	15,3%
Minorities		3.688	0,6%	3.925	0,6%	6,4%
<b>NET INCOME</b>		<b>45.436</b>	<b>8,0%</b>	<b>55.111</b>	<b>8,2%</b>	<b>21,3%</b>





Euro '000	31/12/21	31/12/22	Var.%
Total non current assets	136.648	165.786	21,3%
Net Working Capital	144.641	200.536	38,6%
Other receivables/payables ST	(91.278)	(80.154)	-12,2%
Net financial position	115.766	88.546	-23,5%
Long term liabilities	18.076	18.077	0,0%
Net Equity	287.701	356.637	24,0%
Net capital employed	171.935	268.092	55,9%
Net Working Capital on sales	25,3%	29,8%	
ROCE (EBIT/Net capital employed)	37,7%	30,2%	
Capex	23.150	28.514	

	Euro '000	31/03/22	%	31/03/23	%	Var. %
		unaudited		unaudited		
Medical		87.179	60,4%	96.812	60,0%	11,1%
Industrial		57.205	39,6%	64.543	40,0%	12,8%
<b>Revenues</b>		<b>144.384</b>	<b>100,0%</b>	<b>161.355</b>	<b>100,0%</b>	<b>11,8%</b>
<b>Gross margin</b>		<b>55.013</b>	<b>38,1%</b>	<b>61.123</b>	<b>37,9%</b>	<b>11,1%</b>
Operating Expenses		11.841	8,2%	14.066	8,7%	18,8%
Staff expenses		23.097	16,0%	26.123	16,2%	13,1%
<b>EBITDA</b>		<b>20.075</b>	<b>13,9%</b>	<b>20.934</b>	<b>13,0%</b>	<b>4,3%</b>
Depr., amort., accruals		2.996	2,1%	3.902	2,4%	30,2%
<b>EBIT</b>		<b>17.079</b>	<b>11,8%</b>	<b>17.032</b>	<b>10,6%</b>	<b>-0,3%</b>
Net financ.income(charges)		473	0,3%	(459)	-0,3%	
Other income (expense) net		(7)	0,0%	36	0,0%	
<b>EBT</b>		<b>17.545</b>	<b>12,2%</b>	<b>16.608</b>	<b>10,3%</b>	<b>-5,3%</b>
		31/12/22		31/03/23		
				unaudited		
<b>Net financial position</b>		<b>88.546</b>		<b>56.702</b>		

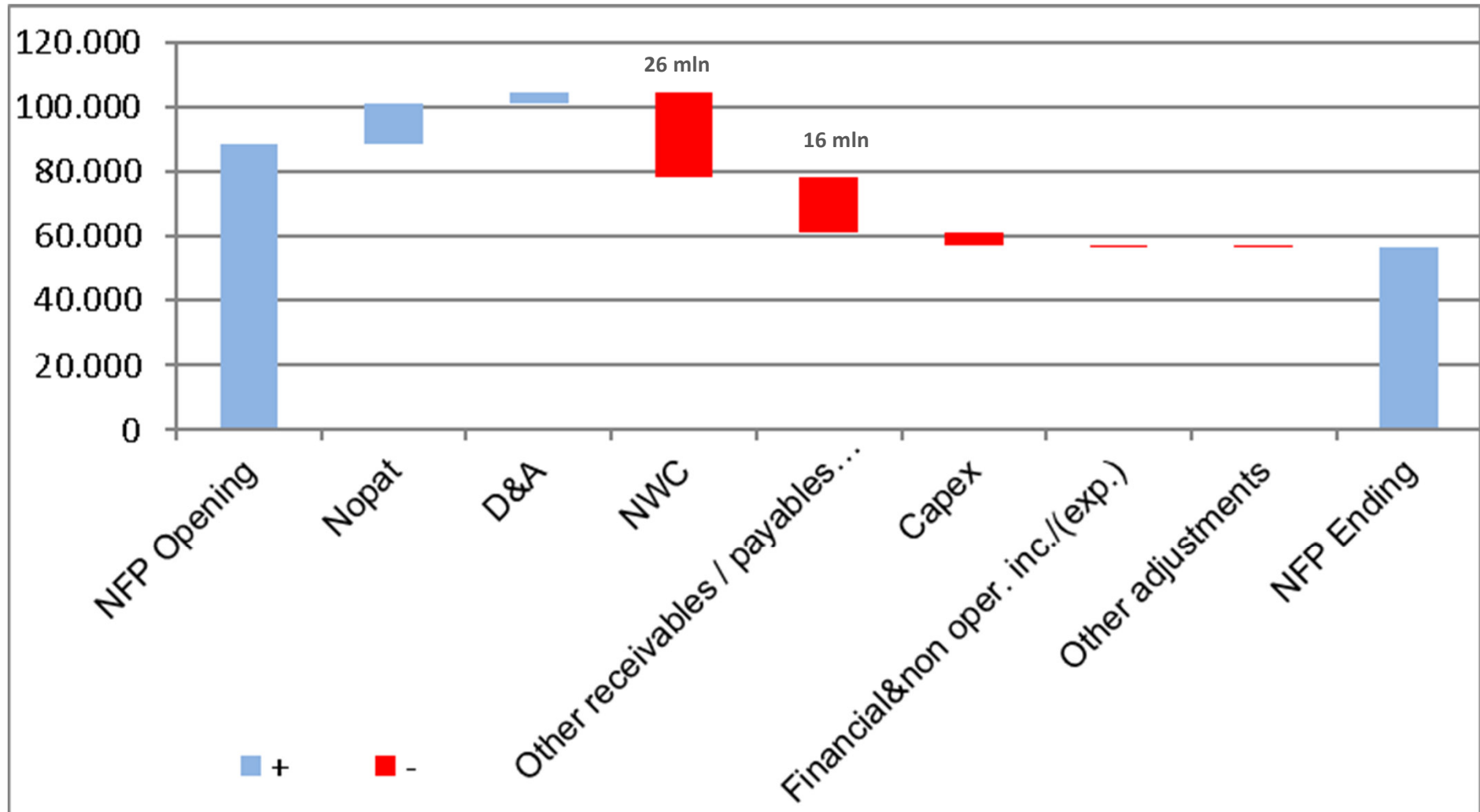

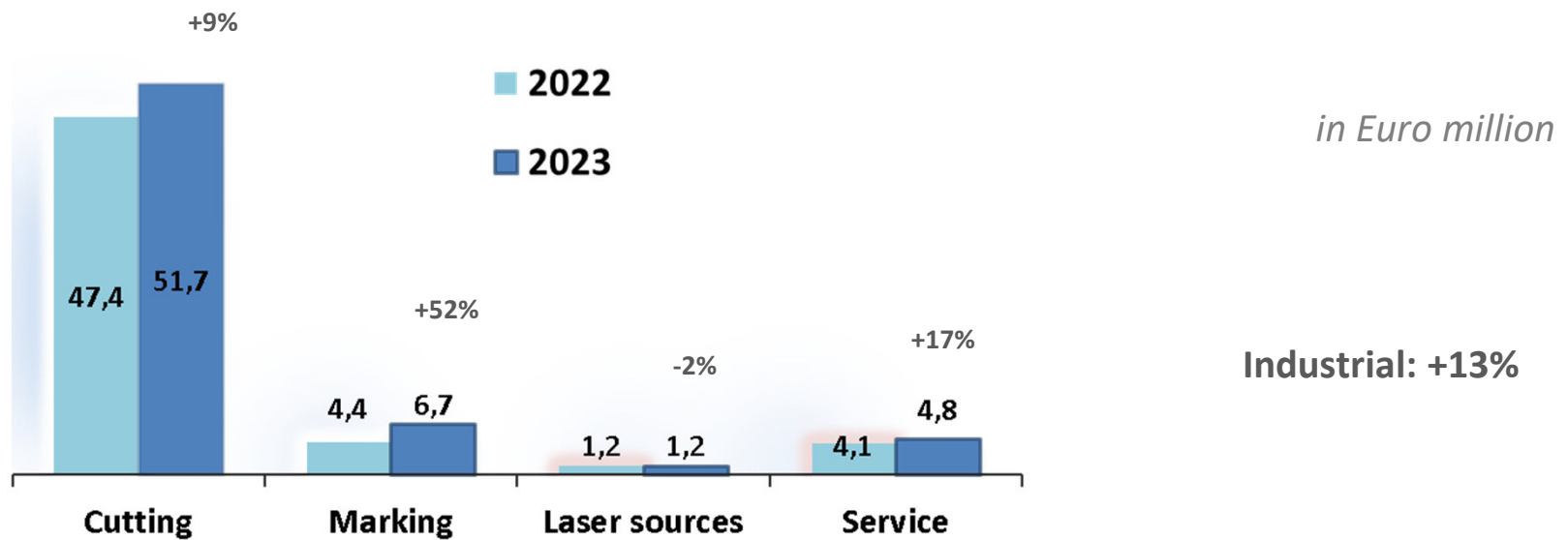
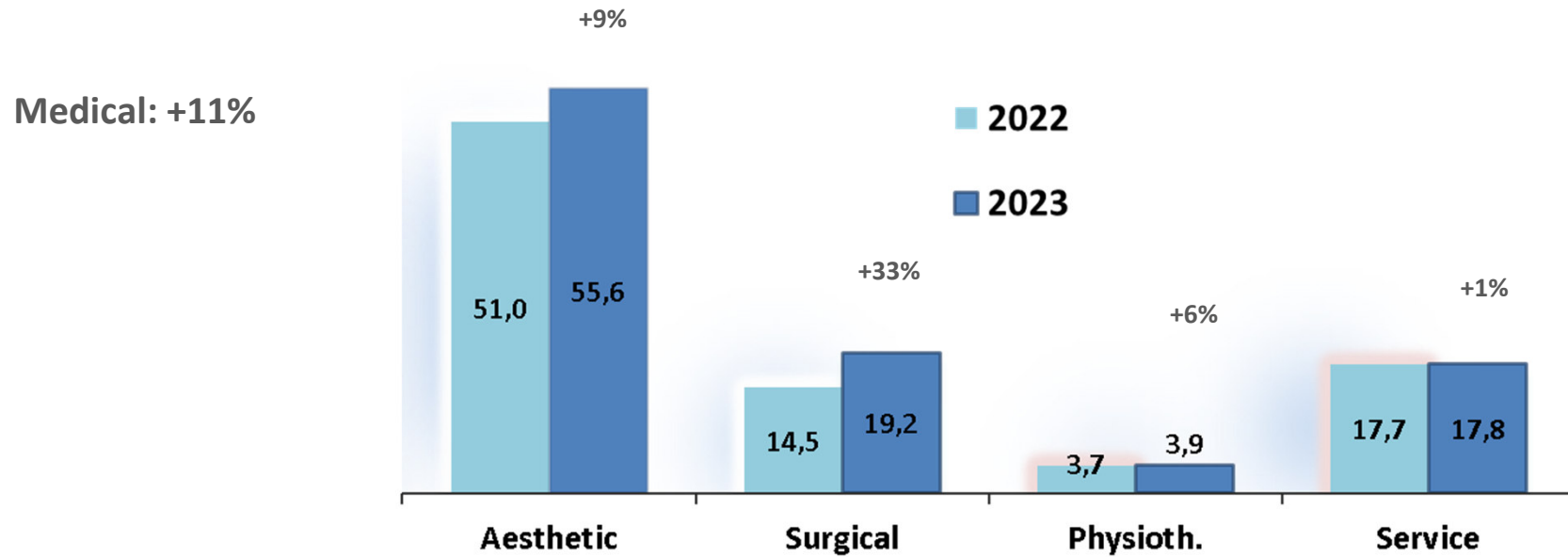



*in Euro million*

## Medical

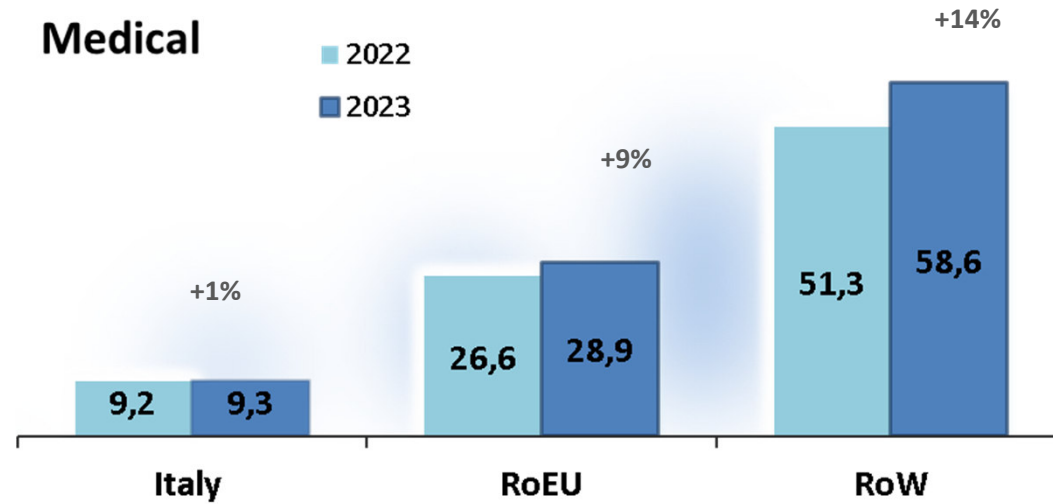

## Industrial

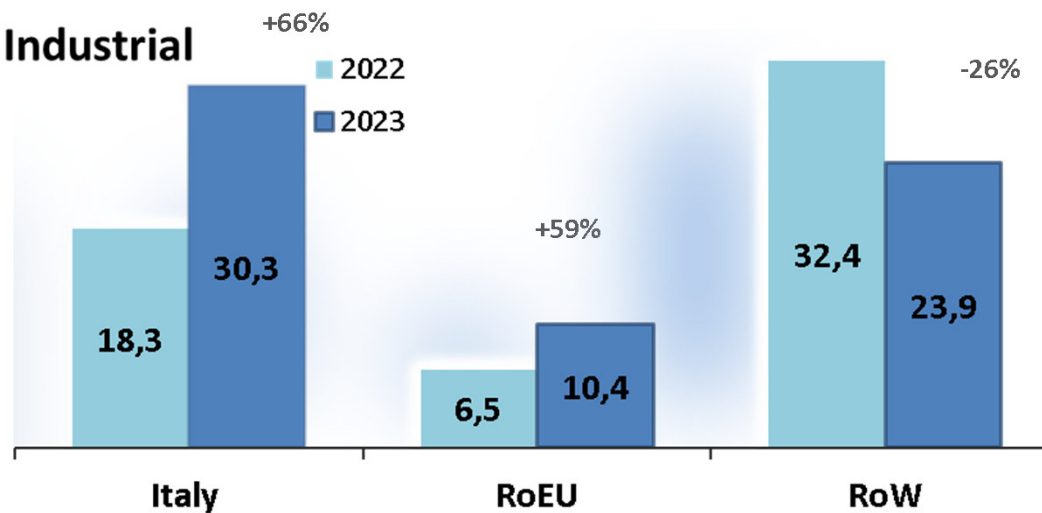

# CURRENT OUTLOOK

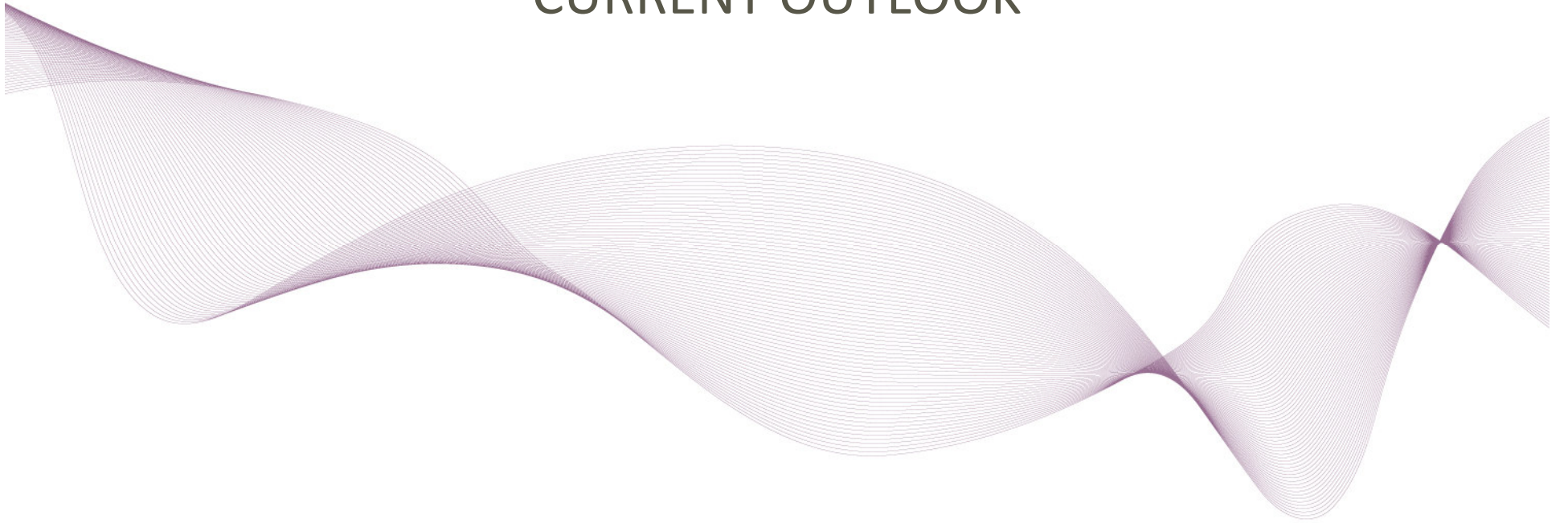



**Revenue 2023 > Revenue 2022**

**EBIT 2023** → **EBIT 2022**



# MULTIPLES & COMPARABLES







<b>Stockholder's Equity per share</b>	<b>4,6</b>
---------------------------------------	------------

<b>Price / Book Value Adj.</b>	<b>2,5</b>
--------------------------------	------------

<b>EV / EBIT (90% EBIT)</b>	<b>13,7</b>
-----------------------------	-------------

<b>EV / Sales (90% Sales)</b>	<b>1,4</b>
-------------------------------	------------

<b>El.En. Market Cap.</b>	<b>917,3 @ € 11,48</b>
---------------------------	------------------------

<b>Net financial position</b>	<b>56,7 @ 31/03/23</b>
-------------------------------	------------------------

<b>Financial investments m/l term</b>	<b>23,5 @ 31/03/23</b>
---------------------------------------	------------------------

<b>Enterprise Value</b>	<b>837,0</b>
-------------------------	--------------



March 31st , 2023

	Price on May 15, 2023	Revenue	Var.% Rev.	EBIT	EBIT %	MK.Cap.	EV	EV/Sales (*)	EV/EBIT (*)	P/Book Value
<b>Medical/Aesthetic</b>										
Cutera	\$15,24	\$55	-5%	\$(24)	-43%	\$302	\$464	2,1	n.a.	n.a.
InMode	\$34,06	\$106	23%	\$41	39%	\$2.830	\$2.258	5,3	13,8	4,7
Beauty Health	\$10,78	\$86	14%	\$(25)	-29%	\$1.430	\$1.650	4,8	n.a.	9,7
Venus	\$3,55	\$21	-22%	\$(8)	-38%	\$284	\$361	4,4	n.a.	n.a.
Sisram Medical (2)	\$1,41	\$354	20%	\$46	13%	\$632	\$594	1,7	12,8	1,5
Lutronic	€ 16,74	€ 46	8%	€ 7	16%	€ 447	€ 387	2,1	13,3	3,8
<b>Industrial</b>										
IPG Photonics Co.	\$111,64	\$347	-6%	\$76	22%	\$5.280	\$4.309	3,1	14,2	2,3
Han's Laser	¥24,08	¥2.425	-28%	¥126	5%	¥24.840	¥24.005	2,5	47,6	1,8
Bystronic (2)	CHF 637	CHF 1.016	8%	CHF 48	5%	CHF 1.160	CHF 708	0,7	14,7	1,6
El.En. (1)	€ 11,48	€ 161	12%	€ 17	11%	€ 917	€ 837	1,4	13,7	2,5

(1) EV and multiplies as for previous slide

(2) Financials on Dec 31st, 2022

(\*) Revenue,Ebit and earnings annualized





## CONTACTS

El.En. S.P.A.

Enrico Romagnoli

*Investor Relations Manager*

tel. +39 055-8826807

E-mail: [finance@elen.it](mailto:finance@elen.it)

## POLYTEMS HIR

*Financial Communication, IR and Press Office*

**Bianca Fersini Mastelloni** - [b.fersini@polytemshir.it](mailto:b.fersini@polytemshir.it)

**Silvia Marongiu** - [s.marongiu@polytemshir.it](mailto:s.marongiu@polytemshir.it)

Tel. +39 06-69923324